

Your Global Automation Partner

**TURCK**

# FS100...L...-2UPN8 Flow Sensors

Instructions for Use

# Contents

- 1 About these instructions ..... 5**
  - 1.1 Target groups ..... 5**
  - 1.2 Explanation of symbols used..... 5**
  - 1.3 Other documents ..... 5**
  - 1.4 Feedback about these instructions ..... 5**
- 2 Notes on the product ..... 6**
  - 2.1 Product identification ..... 6**
  - 2.2 Scope of delivery..... 6**
  - 2.3 Turck service ..... 6**
- 3 For your safety ..... 7**
  - 3.1 Intended use ..... 7**
  - 3.2 Obvious misuse ..... 7**
  - 3.3 General safety notes..... 7**
- 4 Product description ..... 8**
  - 4.1 Device overview ..... 8**
    - 4.1.1 Display and control elements ..... 9
  - 4.2 Properties and features ..... 9**
  - 4.3 Operating and display functions ..... 9**
  - 4.4 Operating principle ..... 9**
  - 4.5 Functions and operating modes ..... 9**
    - 4.5.1 Flow monitoring ..... 9
    - 4.5.2 Temperature monitoring..... 10
    - 4.5.3 IO-Link mode..... 10
    - 4.5.4 SIO mode (standard I/O mode) ..... 10
  - 4.6 Technical accessories ..... 11**
- 5 Installing ..... 12**
  - 5.1 General installation instructions..... 12**
  - 5.2 Special installation instructions..... 13**
- 6 Connecting ..... 14**
  - 6.1 Connecting plug-in devices ..... 14**
    - 6.1.1 Wiring diagram..... 14
- 7 Commissioning ..... 15**
- 8 Operation..... 16**
  - 8.1 LED status indicators — operation..... 16**
  - 8.2 LED indicator bar — flow monitoring..... 17**
  - 8.3 LED indicator bar — temperature monitoring..... 17**
  - 8.4 LEDs — diagnostic messages ..... 18**

- 9 Setting ..... 19**
  - 9.1 Settable functions and properties ..... 19**
  - 9.2 Setting via touchpads ..... 20**
    - 9.2.1 Locking and unlocking the device ..... 20
    - 9.2.2 Setting options ..... 20
    - 9.2.3 Quick-Teach — setting the current flow speed as the switching point ..... 22
    - 9.2.4 MAX/MIN teach-in — setting the switching point for flow ..... 22
    - 9.2.5 MAX/MIN teach-in — setting the indicated range for flow ..... 23
    - 9.2.6 Setting the switching point for temperature ..... 24
    - 9.2.7 Advanced settings ..... 24
  - 9.3 Setting via IO-Link ..... 27**
- 10 Troubleshooting ..... 28**
- 11 Maintenance ..... 29**
- 12 Repair ..... 29**
  - 12.1 Returning devices ..... 29**
- 13 Disposal ..... 29**
- 14 Technical data ..... 30**
- 15 Turck subsidiaries — contact information ..... 32**



# 1 About these instructions

These instructions for use describe the structure, functions and the use of the product and will help you to operate the product as intended. Read these instructions carefully before using the product. This is to avoid possible damage to persons, property or the device. Retain the instructions for future use during the service life of the product. If the product is passed on, pass on these instructions as well.

## 1.1 Target groups

These instructions are aimed at qualified personal and must be carefully read by anyone mounting, commissioning, operating, maintaining, dismantling or disposing of the device.

## 1.2 Explanation of symbols used

The following symbols are used in these instructions:



### **DANGER**

DANGER indicates a dangerous situation with high risk of death or severe injury if not avoided.



### **WARNING**

WARNING indicates a dangerous situation with medium risk of death or severe injury if not avoided.



### **CAUTION**

CAUTION indicates a dangerous situation of medium risk which may result in minor or moderate injury if not avoided.



### **NOTICE**

NOTICE indicates a situation which may lead to property damage if not avoided.



### **NOTE**

NOTE indicates tips, recommendations and useful information on specific actions and facts. The notes simplify your work and help you to avoid additional work.



### **CALL TO ACTION**

This symbol denotes actions that the user must carry out.



### **RESULTS OF ACTION**

This symbol denotes relevant results of actions.

## 1.3 Other documents

Besides this document, the following material can be found on the Internet at [www.turck.com](http://www.turck.com):

- Data sheet
- Declarations of conformity
- IO-Link parameters manual
- Commissioning manual IO-Link devices

## 1.4 Feedback about these instructions

We make every effort to ensure that these instructions are as informative and as clear as possible. If you have any suggestions for improving the design or if some information is missing in the document, please send your suggestions to [techdoc@turck.com](mailto:techdoc@turck.com).

## 2 Notes on the product

### 2.1 Product identification

These instructions apply to the following compact flow sensors:

Type designations	Application area
FS100-...L...-2UPN8-...	Liquid media

### 2.2 Scope of delivery

The scope of delivery includes:

- Compact flow sensor
- Thread adapter for process connection (not with FS100-...-00-...)
- Two seals (not on devices with NPT and R threads)
- Quick Start Guide

### 2.3 Turck service

Turck supports you with your projects, from initial analysis to the commissioning of your application. The Turck product database under [www.turck.com](http://www.turck.com) contains software tools for programming, configuration or commissioning, data sheets and CAD files in numerous export formats.

The contact details of Turck subsidiaries worldwide can be found on p. [▶ 32].

## 3 For your safety

The product is designed according to state-of-the-art technology. However, residual risks still exist. Observe the following warnings and safety notices to prevent damage to persons and property. Turck accepts no liability for damage caused by failure to observe these warning and safety notices.

### 3.1 Intended use

The compact flow sensors in the FS100 product series are used to monitor flow speeds. Typical applications include monitoring cooling circuits (e.g. in welding applications) and protecting pumps from running dry. Based on the calorimetric principle, the devices can also be used to measure the media temperature.

The devices may only be used as described in these instructions. Any other use is not in accordance with the intended use. Turck accepts no liability for any resulting damage.

### 3.2 Obvious misuse

- The devices are not safety components and must not be used for personal or property protection.

### 3.3 General safety notes

- The device may only be assembled, installed, operated, parameterized and maintained by professionally-trained personnel.
- The device may only be used in accordance with applicable national and international regulations, standards and laws.
- The device meets the EMC requirements for industrial areas. When used in residential areas, take measures to avoid radio interference.

## 4 Product description

The compact flow sensors in the FS100...-2UPN8 product series have two programmable (NO/NC) switching outputs. The FS100-...L-...-2UPN8... device variant is designed for liquid media. The sensor and the evaluation electronics are completely encapsulated in a single housing. The appropriate screw-in adapter for the process connection selected by the user (see type designation) is included in the scope of delivery. Screw-in adapters for process connections with other thread sizes are available as optional accessories.

### 4.1 Device overview

The overview shows example dimension drawings of the compact flow sensors.

#### Plug-in devices

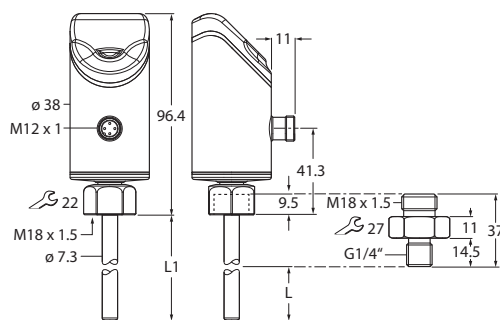

Fig. 1: Dimensions — sensor with G1/4" screw-in adapter

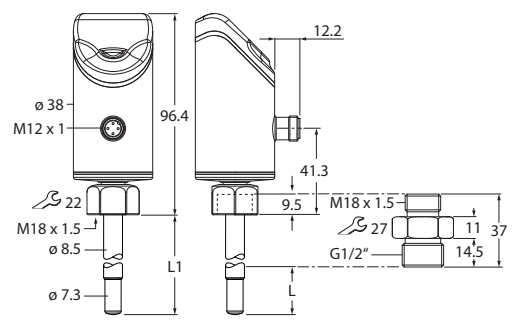

Fig. 2: Dimensions — sensor with G1/2" screw-in adapter

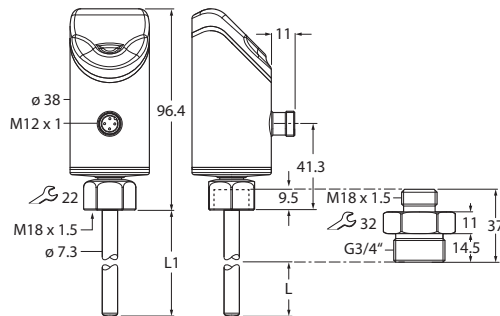

Fig. 3: Dimensions — sensor with G3/4" screw-in adapter

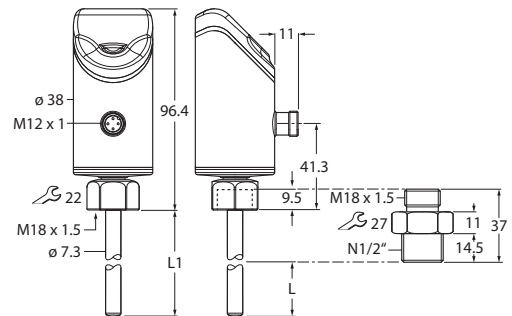

Fig. 4: Dimensions — sensor with NPT 1/2" screw-in adapter

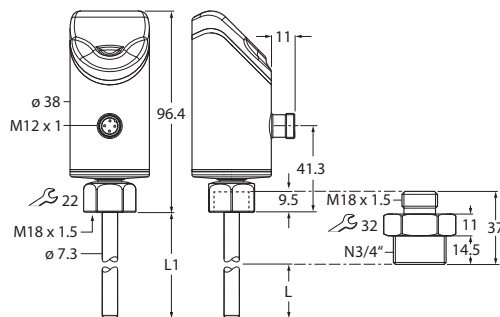

Fig. 5: Dimensions — sensor with NPT 3/4" screw-in adapter

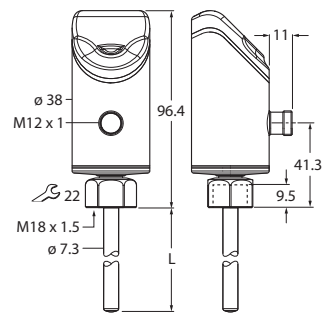

Fig. 6: Dimensions — sensor without screw-in adapter



#### 4.1.1 Display and control elements

The device is equipped with three touch pads, an LED bar and status LEDs on the front. This enables the user to set all essential functions and properties directly on the device and read the actual process values and taught switch points.

#### 4.2 Properties and features

- Flow monitoring for liquid media
- Variants with a thread adapter for process connection
- Sensor housing material 1.4404 (316L)
- Material in contact with medium 1.4571 (316Ti)
- Protection classes IP66, IP67, IP69K
- Process value display via 11-digit LED indicator bar
- Touchpad and/or data storage lock function
- Setting via touchpads or IO-Link interface
- Calibration of the flow speed (setting the switching point/display area) via the teach-in function
- DeltaFlow function: the memory function for teach-in values is only released after the warm-up phase with constant flow
- Output 1 — flow: switching output or IO-Link interface
- Output 2 — temperature: switching output
- Output type: configurable NC/NO contact
- Configurable output configuration: PNP/NPN/Auto Detection

#### 4.3 Operating and display functions

The user can configure and operate the device via three touch pads ([ENTER], [MODE] and [SET]) on the front. An 11-digit LED bar aids parameterization and displays the current flow or temperature values (as selected) in operating mode. Five LEDs indicate the switching status and device status.

#### 4.4 Operating principle

The flow sensors operate calorimetrically. The function is based on the thermo-dynamic principle. When the medium is flowing, thermal energy is dissipated at the sensor. The resulting temperature on the sensor is measured and compared to the medium temperature. The flow status can be derived directly from the determined temperature difference: The greater the energy dissipation, the higher the flow speed or flow rate.

#### 4.5 Functions and operating modes

The FS100...-2UPN8 compact flow sensors monitor the flow speed of liquid media (type FS1...-...L-) as well as the media temperature to determine whether configurable limit values are exceeded or undershot. The devices show the recorded flow and temperature values on the front via status LEDs and an LED bar. The two switching outputs can optionally be used as normally open or normally closed contacts. If the auto detection function is activated, the sensor automatically detects and activates the relevant type of output (PNP/NPN). When operating with an IO-Link master, one of the two digital outputs can also be used as a bidirectional, serial IO-Link interface.

##### 4.5.1 Flow monitoring

The flow speed is detected by a calorimetric sensor in the flow channel and evaluated by the integrated evaluation electronics. The current flow value is displayed via the LED bar and—when connected to an IO-Link master—is output via a communication signal.

The switching output Out 1 (Flow) changes its switching status when the set switching point is reached as a result of the reducing flow rate. If the flow rate increases, the switching status changes when the switching point is undershot by the hysteresis.

#### 4.5.2 Temperature monitoring

The calorimetric measurement method used by the sensors not only monitors the flow speed, but also measures the approximate temperature of the media. Both process variables are recorded and evaluated independently of each other. The current temperature is displayed via the LED bar and—when connected to an IO-Link master (FS...2UPN8)—is output via a communication signal. The current temperature appears on the display when the [SET] touchpad is pressed and held in display mode.

The switching output Out 2 (Temp) is used for temperature monitoring. The devices change their switching status when the set switching point is reached due to a rising temperature. If the temperature drops, the switching status changes when the switching point is undershot by the hysteresis.

#### 4.5.3 IO-Link mode

In order to operate in IO-Link mode, the device must be connected to an IO-Link master. When the port is configured in IO-Link mode, bidirectional IO-Link communication takes place between the IO-Link master and the device. To make this possible, the device is integrated via an IO-Link master at the control level. First the communication parameters are exchanged, and then the cyclic data exchange of process data (objects) starts.

In IO-Link mode, both cyclic and acyclic communication services for exchanging device data (parameter values, identification data and diagnostic information) are available. The IO-Link master always sends a request to the device first, and then the device responds. This is the case both when the data is written into the device and read from the device.

#### 4.5.4 SIO mode (standard I/O mode)

In standard I/O mode no IO-Link communication takes place between the device and the master. The device only transfers the switching state of its binary outputs and can also be run via a fieldbus device or controller with digital PNP or NPN inputs. An IO-Link master is not required for operation.

The device parameters can be set via IO-Link and then operated at the digital inputs with the appropriate settings in SIO mode. Not all functions and properties of the device can be used in SIO mode.

## 4.6 Technical accessories

The screw-in adapters are available for different threads. This allows the device to be flexibly adapted to different process connections. Additional adapters can be ordered separately as accessories.

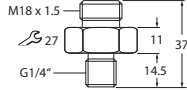
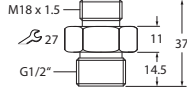
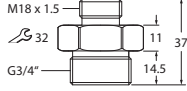
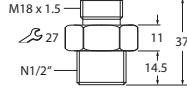
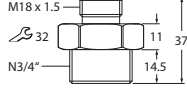
Dimension drawing	Type	ID	Description
	FAA-04-1.4571	100001989	Screw-in adapter for immersion sensors from the FS..., FP... product series; material: stainless steel 1.4571 (316Ti); process connection: G1/4"
	FAA-80-1.4571	100001988	Screw-in adapter for immersion sensors from the FS..., FP... product series; material: stainless steel 1.4571 (316Ti); process connection: G1/2"
	FAA-81-1.4571	100001991	Screw-in adapter for immersion sensors from the FS..., FP... product series; material: stainless steel 1.4571 (316Ti); process connection: G3/4"
	FAA-A1-1.4571	100001987	Screw-in adapter for immersion sensors from the FS..., FP... product series; material: stainless steel 1.4571 (316Ti); process connection: N1/2"
	FAA-34-1.4571	100001990	Screw-in adapter for immersion sensors from the FS..., FP... product series; material: stainless steel 1.4571 (316Ti); process connection: N3/4"

## 5 Installing

### 5.1 General installation instructions

- ▶ For optimal monitoring, mount the sensor such that the probe rod is fully immersed in the medium.
- ▶ If the medium flows in a horizontal direction and may contain deposits or trapped gas (e.g. air bubbles): Mount the sensor e.g. laterally.

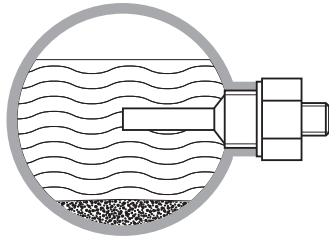

Fig. 7: Lateral mounting

- ▶ If the medium flows in a horizontal direction and the flow channel is not completely filled with the medium: Mount the sensor e.g. below the flow.

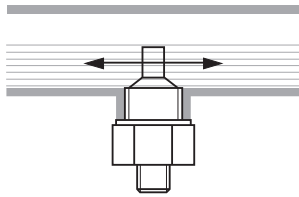

Fig. 8: Mounting below the flow

- ▶ If the medium flows in a vertical direction: Mount the sensor only in risers.
- ▶ A minimum distance from potential interference variables (pumps, valves, flow rectifiers, pipe bends, changes in the cross section) must be maintained.

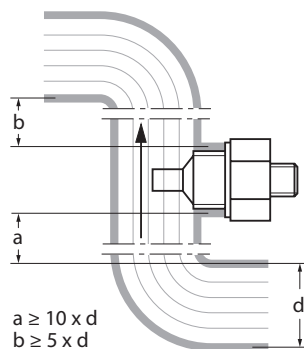

Fig. 9: Minimum distances to interference variables

- ▶ Prevent the tip of the probe rod coming into contact with the opposite side of the flow channel inner wall.

## 5.2 Special installation instructions

- ▶ Only mount Turck sensors from the FS product series using screw-in adapters from the FAA-... product series.
- ▶ For devices with a G...” process connection: Position one of the two seals (included in the delivery) between the screw-in adapter and the process connection (e.g. union).
- ▶ Screw the screw-in adapter onto the process connection (maximum torque of 100 Nm).
- ▶ Guide the probe rod through the screw-in adapter and hand-tighten the sensor (M18 × 1.5 coupling nut) with the screw-in adapter.
- ▶ For a standard flow range (3...300 cm/s): The probe rod can be installed in the medium independent of the flow direction (range of 360°).
- ▶ For an extended flow range (1...300 cm/s): Mount the probe rod directed so that the medium flows toward the prick punch mark, tolerance range of ± 45°.

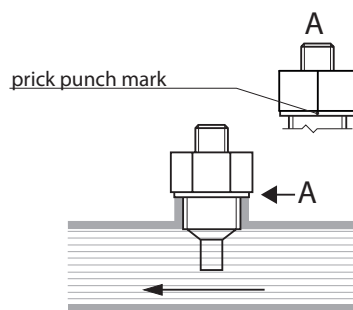

Fig. 10: Mount the probe rod directed correctly

- ▶ Screw an M18 × 1.5 coupling nut onto the screw-in adapter (maximum torque of 40 Nm).
- ▶ Optional: For optimum operation and readability, adjust the sensor head within a range of 340°.
- ▶ For devices with a G...” process connection: After removing and reinstalling the screw-in adapter, use a new seal (replacement seal included in the delivery).
- ▶ After removing and reinstalling the sensor, teach in new teach-in values.

## 6 Connecting

### 6.1 Connecting plug-in devices

- ▶ Connect the connection cable coupling to the sensor connector.
- ▶ Connect the connection cable to the power source as shown in the wiring diagram.

#### 6.1.1 Wiring diagram

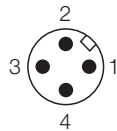

Fig. 11: Pin assignment

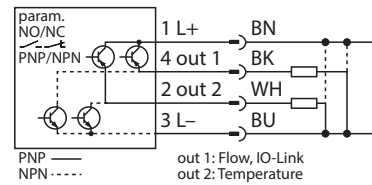

Fig. 12: FS100-...-2UPN8-H1141 wiring diagram

## 7 Commissioning

After switching on the operating voltage, the DeltaFlow function monitors the warm-up phase of the sensor. During this phase, the LED indicator bar flashes yellow and the two output LEDs FLOW and TEMP are switched off.

The warm-up phase is deemed to be complete:

- If the period of 30 seconds that is allotted for the warm-up phase has elapsed.
- If the system is in a stable condition, i.e. the change in flow rate is sufficiently small.

After the warm-up phase, the device is ready for use and automatically switches to display mode for the flow speed.

## 8 Operation



### WARNING

The housing can heat up to over 75 °C (167 °F) in the area of the probe  
**Risk of burning due to hot housing surfaces!**

- ▶ Protect the housing from contact with flammable material.
- ▶ Protect the housing from accidental contact.

### 8.1 LED status indicators — operation

The LEDs indicate readiness for operation, the status of the outputs and pending diagnostic messages. An additional LED indicates that the device has been locked.



LED	Indication	Meaning
PWR	Green	Device is operational
	Green flashing	IO-Link communication active (inverted: T <sub>on</sub> : 900 ms/T <sub>off</sub> : 100 ms)
FLOW	Yellow	NO switching output: Switching point exceeded (HIGH level) NC switching output: Switching point undershot (HIGH level)
	Yellow flashing	See "LEDs — diagnostic messages"
	Off	NO switching output: Switching point undershot (LOW level) NC switching output: Switching point exceeded (LOW level)
TEMP	Yellow	NO switching output: Switching point exceeded (HIGH level) NC switching output: Switching point undershot (HIGH level)
	Yellow flashing	See "LEDs — diagnostic messages"
	Off	NO switching output: Switching point undershot (LOW level) NC switching output: Switching point exceeded (LOW level)
LOC	Yellow	Device locked
	Yellow flashing	"Lock/unlock" process active
	Off	Device unlocked
FLT	Red	Error, see "LED Indicators — diagnostic Messages"



## 8.2 LED indicator bar — flow monitoring



### Quick-Teach mode — LED indicator bar

In Quick-Teach mode, the LED indicator bar refers to a fixed indicated range that spans around the taught-in FLOW switching point. This indicated range covers approximately 5 % of the total sensing range. The switching point set in Quick-Teach mode is indicated in the LED bar by a yellow LED; deviations from this switching point are indicated in 0.5 % increments by green LEDs. Green LEDs to the left of the yellow switching point LED indicate that the switching point is being undershot, green LEDs to the right of the yellow switching point LED indicate that the switching point is being exceeded.

Quick-Teach mode	LED indicator bar
Green LEDs: Indicate the flow deviation proportional to the set switching point (yellow LED).	
Flow speed below the switching point:	
Flow speed above the switching point:	

### MAX/MIN mode — LED indicator bar



The FLOW switching point is set as a percentage value within a previously taught-in MAX/MIN indicated range. The switching point (yellow LED) and flow speed (green LEDs) are displayed in the LED bar by 11 LEDs proportional to the indicated range. Flow values that deviate from the FLOW switching point are indicated in 9.1 % increments by green LEDs. Green LEDs to the left of the yellow switching point LED indicate that the switching point is being undershot, green LEDs to the right of the yellow switching point LED indicate that the switching point is being exceeded.

MAX/MIN mode	LED indicator bar
Green LEDs: Indicate the flow deviation proportional to the set switching point (yellow LED).	
Flow speed below the switching point:	
Flow speed above the switching point:	



## 8.3 LED indicator bar — temperature monitoring

- ▶ To display the temperature: Press and hold [SET] in display mode.

The TEMP switching point is set as a temperature value within a fixed indicated range of -40 °C...+180 °C/-40 °F...+356 °F. The switching point (green LED) and media temperature (yellow LEDs) are displayed in the LED bar proportional to the indicated range (0...11 LEDs: -40 °C...+180 °C/-40 °F...+356 °F). Media temperatures deviating from the TEMP switching point are indicated in 20 ° increments by yellow LEDs. Yellow LEDs to the left of the green switching point LED indicate that the switching point is being undershot, yellow LEDs to the right of the green switching point LED indicate that the switching point is being exceeded.

Temperature monitoring	LED indicator bar
Green LEDs: Indicate the media temperature proportional to the indicated range (0...11 LEDs: -40 °C...+180 °C/-40 °F...+356 °F). Yellow LED: Indicates the set switching point proportional to the indicated range.	
Temperature below the switching point:	
Temperature above the switching point:	

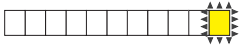
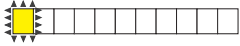
## 8.4 LEDs — diagnostic messages

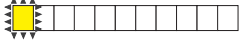
LEDs — diagnostic messages			LED indicator bar	Error
FLOW	TEMP	FLT		
Yellow flashing	–	–		Flow speed above the indicated range
Yellow flashing	–	–		Flow speed below the indicated range
–	Yellow flashing	–		Media temperature above the indicated range
–	Yellow flashing	–		Media temperature below the indicated range
Yellow flashing	–	Red	–	Short circuit at transistor output Out1
–	Yellow flashing	Red	–	Short circuit at transistor output Out1
–	–	Red	–	General error (shut down all outputs, manual reset required)

## 9 Setting

### 9.1 Settable functions and properties

The three front touchpads (ENTER, MODE, SET) enable the user to set all the essential functions and properties directly on the device via the menu guidance. It is also possible to configure the device via the IO-Link interface (see IO-Link parameter manual).

#### Setting options – via touchpads and IO-Link interface

The following functions and properties can be set and used both in standard I/O mode as well as in IO-Link mode.

- Locking/unlocking touchpads
- FLOW switching point: Quick-Teach
- FLOW switching point: MAX/MIN teach-in
- Indicated range: MAX/MIN teach-in
- TEMP switching point
- Advanced settings: Reset to the previous settings (Pre-Settings)
- Advanced settings: Reset to factory settings
- Advanced settings: Output FLOW: NO/NC changeover
- Advanced settings: Output TEMP: NO/NC changeover

#### Other setting options — only via IO-Link

Additional functions and properties can also be set via the IO-Link interface.

- OUT1 output configuration for SIO mode: PNP/NPN, automatic detection on/off
- OUT2 output configuration for SIO mode: PNP/NPN, automatic detection on/off
- Setting display units for IO-Link mode: metric, imperial
- Lock data storage on IO-Link master
- Fully lock user interface (display and touchpads locked)
- Lock parameters (parameters are displayed but cannot be changed)

#### Factory settings

- Medium: water
- Flow switching point: 70 % of the indicated range
- MAX/MIN mode
- MAX value: maximum
- MIN value: minimum
- Temperature switching point: 60 °C
- Output function Out 1: NO contact
- Output function Out 2: NO contact
- Automatic detection function on

#### Automatic detection function

The Automatic detection function supports the error-free configuration of the sensor for connecting to the remote I/O environment: The sensor automatically activates the output signal that corresponds to the signal type of the connected input card. The Automatic detection function is active by default. The output can also be set selectively as required via the IO-Link interface.

## 9.2 Setting via touchpads

### 9.2.1 Locking and unlocking the device

To prevent accidental entries, the touch pads are automatically locked after switching on and after 5 minutes without being pressed (after 30 minutes in setting mode). If the key lock is activated, teach-in procedures cannot be initiated and parameters cannot be changed.

#### Locking the device (LOC)

- ▶ Press and hold [MODE] and [SET] for 3 s.
- ⇒ The LOC LED first flashes and then turns a constant yellow.

#### Unlocking the device (uLOC)

- ▶ Press and hold [ENTER] until all the LEDs in the LED bar turn green and the LED bar briefly flashes green twice.

#### LED indicator bar

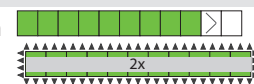

- ▶ Swipe across each the touchpads with your finger — in the order [MODE], [ENTER], [SET] until all the LEDs (3 × 3) in the LED bar are flashing green.



- ▶ Release the touchpads.



- ⇒ The LOC LED flashes first and then goes out.

### 9.2.2 Setting options

The user can set the main device functions directly on the device via the touchpads [ENTER], [MODE] and [SET]:

#### Setting options — devices with switching output for flow monitoring

- |   |  |  |
|---|--|--|
| ① | FLOW switching point: Quick-Teach      | Quick-Teach: Current flow speed is directly taught in as the FLOW switching point                        |
| ② | FLOW switching point: MAX/MIN teach-in | MAX/MIN teach-in: Set the FLOW switching point as a percentage of a configurable MAX/MIN indicated range |
| ③ | Indicated range: MAX/MIN teach-in      | MAX/MIN teach-in: Teach in the upper and lower limit values for the flow monitoring indicated range      |
| ④ | TEMP switching point                   | Set the TEMP switching point in increments of 2 °C from -40...+180 °C                                    |
| ⑤ | Advanced settings                      | Reset to last setting  |
|   |  | Reset to factory setting   |
|   |  | Change FLOW output over to NO/NC   |
|   |  | Change TEMP output over to NO/NC   |

Flow chart — setting the device via touchpads

The following overview shows the various setting options and operating steps:

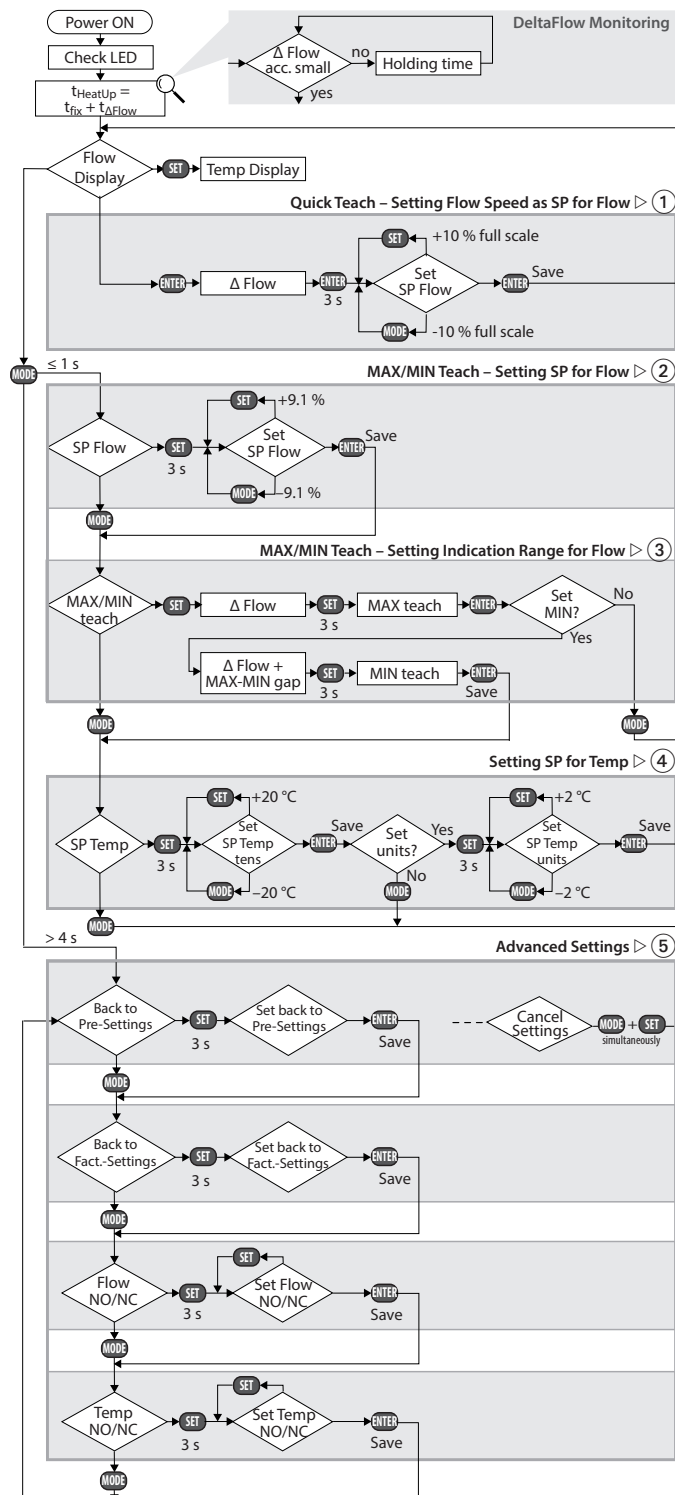
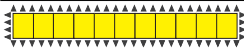
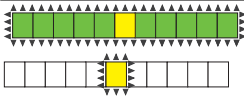

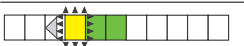
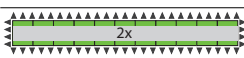

Fig. 13: Setting via touchpads — flow chart

### 9.2.3 Quick-Teach — setting the current flow speed as the switching point

With the Quick-Teach function, the current flow speed can be directly taught in as the switching point FLOW for devices with a switching output; setting a separate MAX/MIN indicated range is not required.

The Quick-Teach function for teaching in the switching point is marked in the flow chart with ①.



Menu	LED indicator bar
<b>Setting the current flow speed as the switching point</b>	
1 Operate the flow speed in the application at the upper limit value.	
2 ▶ To access the menu from display mode: Press [ENTER] once. ⇒ DeltaFlow active: LED 11 in the LED bar is flashing yellow. System has not yet stabilized. ▶ Wait until the LED is flashing green.	
▶ Once the LED bar is flashing green, the system has stabilized: Press [ENTER] for 3 s until only LED 6 is flashing yellow. ⇒ The current flow speed is taught in as the switching point.	
3 Optional: Change the switching point incrementally by 0.5 %:	
▶ Increase the switching point incrementally by 0.5 % of the measuring range end value: Press [SET].	
▶ Reduce the switching point incrementally by 0.5 % of the measuring range end value: Press [MODE].	
4 ▶ Store the switching point: Press [Enter]. ⇒ LED bar briefly flashes green twice.	

### 9.2.4 MAX/MIN teach-in — setting the switching point for flow

With the MAX/MIN teach-in function, the FLOW switching point is taught in as a percentage value within an adjustable MAX/MIN indicated range for devices with a switching output.

The MAX/MIN teach-in function for setting the switching point is marked in the flow chart with ②.

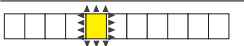
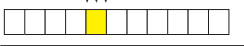
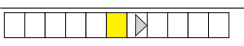
- ▶ To open from display mode: Press [MODE] once.

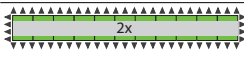
Menu	LED indicator bar
<b>Setting the switching point for flow monitoring</b>	
1 Press and hold [SET] for 3 s until the switching point LED first flashes yellow and then changes to a constant yellow again.	 
2 Set the switching point:	
▶ Increase the switching point incrementally by 9.1 %: Press [SET].	
▶ Reduce the switching point incrementally by 9.1 %: Press [MODE].	
3 Store the switching point:	
▶ Press [Enter]. ⇒ LED bar briefly flashes green twice.	

## 9.2.5 MAX/MIN teach-in — setting the indicated range for flow

The MAX/MIN teach-in function for teaching in the indicated range is marked in the flow chart with ③.

- ▶ To open from display mode: Press [MODE] twice.

Menu	LED indicator bar
<b>Setting the indicated range for the flow</b>	
1 Set the upper limit value:	
▶ Operate the flow speed in the application at the upper limit value and press [SET] once.	
⇒ DeltaFlow active: LED 11 in the LED bar flashes yellow, system not yet stabilized.	
▶ Wait until the LED is flashing green.	
▶ Once the LED bar is flashing green, the system has stabilized: Press [SET] for 3 s until only LED 11 is a constant green.	
▶ Store the upper limit value: Press [ENTER].	
⇒ LED bar briefly flashes green twice.	
2 Set the lower limit value:	
▶ Operate the flow speed in the application at the lower limit value.	
⇒ The system checks the MAX/MIN offset	
▶ LED moves to position 1 and flashes yellow: MAX/MIN offset OK DeltaFlow active: System has not yet stabilized: Wait until LED 1 flashes green	
▶ LED does not move to position 1 and flashes yellow: MAX/MIN offset too small: Reduce the flow speed	
▶ Once LED 1 in the LED bar is flashing green, the system has stabilized: Press [SET] for 3 s until LED 1 in the LED bar is a constant green.	
▶ Store the lower limit value: Press [ENTER].	
⇒ LED bar briefly flashes green twice. The next menu appears.	

## 9.2.6 Setting the switching point for temperature

The function for setting the switching point for the temperature is marked in the flowchart with ④.

- ▶ To open from display mode: Press [MODE] three times.

Menu	LED indicator bar
<b>Setting the switching point for temperature monitoring</b>	
1 Set the tens digit of the temperature value:	
▶ Press and hold [SET] for 3 s until the switching point LED first flashes yellow and then changes to a constant yellow again.	
▶ Increase the switching point in increments of 20 °C: Press [SET].	
▶ Reduce the switching point in increments of 20 °C: Press [MODE].	
2 Store the switching point: Press [ENTER] once until the LED bar flashes twice briefly.	
3 Set the units digit of the temperature value:	
▶ Press and hold [SET] for 3 s until the switching point LED first flashes yellow and then changes to a constant yellow again.	
▶ Increase the switching point in increments of 2 °C: Press [SET].	
▶ Reduce the switching point in increments of 2 °C: Press [MODE].	
4 Store the switching point: Press [ENTER] once until the LED bar flashes twice briefly.	

## 9.2.7 Advanced settings

The following functions and properties can be set and used as advanced settings.

- Advanced settings: Reset to the previous settings (Pre-Settings)
- Advanced settings: Reset to factory settings
- Advanced settings: Output FLOW: NO/NC changeover
- Advanced settings: Output TEMP: NO/NC changeover

The advanced settings are marked in the flowchart with ⑤.



Starting or exiting the "advanced settings" menu sequence

Starting/exiting the "advanced settings" menu sequence	LED indicator bar
To start <b>advanced settings</b> :	
▶ Press [MODE] for at least 4 s until all LEDs in the LED bar turn green and the LED bar briefly flashes green twice.	
To exit <b>advanced settings</b> :	
▶ Automatically: Do not press the touchpads for at least 30 s.	
▶ Manually: Press [MODE] + [SET] simultaneously once.	



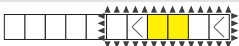

## Reset to the previous settings (Pre-Settings)

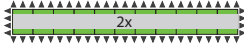
The device includes a function that allows you to reset the current settings to the previous device settings: "Back to Pre-Settings."

Menu	LED indicator bar
<b>Resetting to the previous settings:</b> LEDs 11...6 will flash yellow one after the other.	
Reset to last saved setting:	
<ul style="list-style-type: none"> <li>▶ Press [SET] for at least 3 s until LEDs 11...6 quickly flash green one after the other.</li> </ul>	
<ul style="list-style-type: none"> <li>▶ Save settings: Press [ENTER].                              ⇒ LED bar briefly flashes green twice. The next menu appears.</li> </ul>	





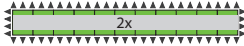



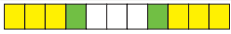

## Reset to factory settings

The device includes a feature that allows you to reset the current settings to the factory settings: "Back to Factory-Settings".

Menu	LED indicator bar
<b>Reset to factory settings:</b> LEDs 11...1 will flash yellow one after the other.	
Reset to factory settings:	
<ul style="list-style-type: none"> <li>▶ Press [SET] for at least 3 s until LEDs 11...1 quickly flash green one after the other.</li> </ul>	
<ul style="list-style-type: none"> <li>▶ Save settings: Press [ENTER].                              ⇒ LED bar briefly flashes green twice. The next menu appears.</li> </ul>	

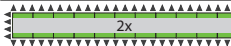



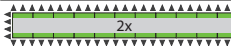



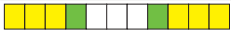

## Output FLOW: NO/NC changeover

The switching outputs can optionally be used as normally open or normally closed. If the sensor has more than one switching output, the outputs can be configured differently. Each switching output is configured as normally open by default.

Menu	LED indicator bar
<b>Display of the current (active) output function:</b>	
NO (normally open)	
NC (normally closed)	
<b>A Changing the FLOW output from NO to NC</b> LEDs 5...7 off (NO), LEDs 4 and 8 flash green.	
Change the output function from NO to NC:	
▶ Press and hold [SET] for at least 3 s until LEDs 4 and 8 first flash green quickly and then return to a constant green.	
▶ Press [SET].	
⇒ LEDs 4...8 are green (NC).	
▶ Save the output function: Press [Enter].	
⇒ LED bar briefly flashes green twice. The next menu appears.	
<b>B Changing the FLOW output from NC to NO</b> LEDs 4...8 are green (NC), LEDs 4 and 8 flash green.	
Change output function from NC to NO:	
▶ Press and hold [SET] for at least 3 s until green LEDs 4 to 8 first flash green quickly and then return to a constant green.	
▶ Press [SET].	
⇒ LEDs 5...7 off (NO)	
▶ Save the output function: Press [Enter].	
⇒ LED bar briefly flashes green twice. The next menu appears.	

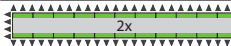
## Output TEMP: NO/NC changeover

The switching outputs can optionally be used as normally open or normally closed. If the sensor has more than one switching output, the outputs can be configured differently. Each switching output is configured as normally open by default.

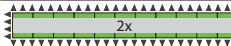
Menu	LED indicator bar
<b>Display of the current (active) output function:</b>	
NO (normally open)	
NC (normally closed)	
<b>A Changing the TEMP output from NO to NC</b> LEDs 5...7 off (NO), LEDs 4 and 8 flash green.	
Change the output function from NO to NC:	
▶ Press and hold [SET] for at least 3 s until LEDs 4 and 8 first flash green quickly and then return to a constant green.	
▶ Press [SET].	
⇒ LEDs 4...8 are green (NC).	
▶ Save the output function: Press [Enter].	
⇒ LED bar briefly flashes green twice. The next menu appears.	
<b>B Changing the TEMP output from NC to NO</b> LEDs 4...8 are green (NC), LEDs 4 to 8 flash green.	
Change output function from NC to NO:	
▶ Press and hold [SET] for at least 3 s until green LEDs 4 to 8 first flash green quickly and then return to a constant green.	
▶ Press [SET].	
⇒ LEDs 5...7 off (NO)	
▶ Save the output function: Press [Enter].	
⇒ LED bar briefly flashes green twice. The next menu appears.	

## 9.3 Setting via IO-Link

The device can be parameterized within the technical specifications (see data sheet) via the IO-Link communication interface — both offline, e.g. with the configuration tool, and online via the controller. An overview of the different functions and properties that can be set and used for IO-Link mode or SIO can be found in chapter 8 "Setting" and in the IO-Link parameter manual for the device. Detailed instructions on the parameterization of devices via the IO-Link interface are provided in the IO-Link commissioning manual.

All parameters can be changed in IO-Link mode via the controller, both during commissioning and during operation. In SIO mode, the device operates in accordance with the most recent setting configured in IO-Link mode.

## 10 Troubleshooting

If the device does not function as expected, first check whether there is any ambient interference. If there is no ambient interference, check the connections of the device for faults.

If no faults are identified, this indicates that the device is faulty. In this case, decommission the device and replace it with a new device of the same type.

## 11 Maintenance

The maintenance requirements of the particular system apply to the devices.  
No other device-specific maintenance measures are required.

## 12 Repair

The device must not be repaired by the user. The device must be decommissioned if it is faulty.  
Observe our return acceptance conditions when returning the device to Turck.

### 12.1 Returning devices

Returns to Turck can only be accepted if the device has been equipped with a Decontamination declaration enclosed. The decontamination declaration can be downloaded from <https://www.turck.de/en/retoure-service-6079.php> and must be completely filled in, and affixed securely and weather-proof to the outside of the packaging.

## 13 Disposal



The devices must be disposed of correctly and must not be included in general household garbage.

## 14 Technical data

<b>Technical data</b>	
<b>Application area</b>	
Mounting conditions	Immersion sensor
Application area	FS100-...L: liquid media
Ambient temperature	-25...+85 °C
Temperature of medium	-25...+85 °C
Storage temperature	-40...+100 °C
Pressure resistance	300 bar
<b>Electrical data</b>	
Operating voltage	10...33 VDC
Output function	NO/NC programmable, PNP/NPN
Output 1	Flow: Switching output or IO-Link
Output 2	Temperature: Switching output
Communication protocol	IO-Link
Power consumption	≤ 1.5 W
Voltage drop	≤ 1.8 VDC
Continuous current carrying capacity of the DC switching output	250 mA
Short-circuit protection	Yes, cyclic
Overload protection	Yes
Reverse polarity protection	Yes
Standby delay time (min)	18 s
<b>IO-Link</b>	
IO-Link specification	V1.1
IO-Link port type	Class A
Transmission rate	COM 2 (38.4 kBaud)
Physical transmission layer	3-wire technology (PHY2)
Minimum cycle time	6 ms
Frame type	2.2
SIO mode supported	Yes
Block parameters	Yes
Data storage:	Yes
<b>Standard/Directive conformity</b>	
Vibration testing	Acc. to EN 60068-2-27
Shock testing	Acc. to EN 60068-2-27
EMC (electromagnetic compatibility)	Acc. to EN 55011, EN 60947-5-9, EN 61000-3-2, EN 61000-3-3
Approvals	CE, cULus
<b>Mechanical data</b>	
Housing material	Stainless steel, 1.4404 (316L)
Material (in direct contact with media)	Stainless steel, 1.4571 (316Ti), FKM O-ring, AFM flat seal (only for devices with a G..." process connection)
Electrical connection	Connector device: Male connector, M12 × 1, 4-pin

**Technical data**

Type of protection	IP66, IP67, IP69K
MTF	120 years acc. to SN 29500 (Ed 99) 40 °C
Display functions	LEDs indicate the status of the power supply, outputs and teach-in processes, display of the process values via LED bar

## 15 Turck subsidiaries — contact information

<b>Germany</b>	Hans Turck GmbH & Co. KG Witzlebenstraße 7, 45472 Mülheim an der Ruhr <a href="http://www.turck.de">www.turck.de</a>
<b>Australia</b>	Turck Australia Pty Ltd Building 4, 19-25 Duerdin Street, Notting Hill, 3168 Victoria <a href="http://www.turck.com.au">www.turck.com.au</a>
<b>Austria</b>	Turck GmbH Graumanngasse 7/A5-1, A-1150 Wien <a href="http://www.turck.at">www.turck.at</a>
<b>Belgium</b>	TURCK MULTIPROX Lion d'Orweg 12, B-9300 Aalst <a href="http://www.multiprox.be">www.multiprox.be</a>
<b>Brazil</b>	Turck do Brasil Automação Ltda. Rua Anjo Custódio Nr. 42, Jardim Anália Franco, CEP 03358-040 São Paulo <a href="http://www.turck.com.br">www.turck.com.br</a>
<b>Canada</b>	Turck Canada Inc. 140 Duffield Drive, CDN-Markham, Ontario L6G 1B5 <a href="http://www.turck.ca">www.turck.ca</a>
<b>China</b>	Turck (Tianjin) Sensor Co. Ltd. 18,4th Xinghuazhi Road, Xiqing Economic Development Area, 300381 Tianjin <a href="http://www.turck.com.cn">www.turck.com.cn</a>
<b>Czech Republic</b>	TURCK s.r.o. Na Brne 2065, CZ-500 06 Hradec Králové <a href="http://www.turck.cz">www.turck.cz</a>
<b>France</b>	TURCK BANNER S.A.S. 11 rue de Courtalin Bat C, Magny Le Hongre, F-77703 MARNE LA VALLEE Cedex 4 <a href="http://www.turckbanner.fr">www.turckbanner.fr</a>
<b>Great Britain</b>	TURCK BANNER LIMITED Blenheim House, Hurricane Way, GB-SS11 8YT Wickford, Essex <a href="http://www.turckbanner.co.uk">www.turckbanner.co.uk</a>
<b>Hungary</b>	TURCK Hungary kft. Árpád fejedelem útja 26-28., Óbuda Gate, 2. em., H-1023 Budapest <a href="http://www.turck.hu">www.turck.hu</a>
<b>India</b>	TURCK India Automation Pvt. Ltd. 401-403 Aurum Avenue, Survey. No 109 /4, Near Cummins Complex, Baner-Balewadi Link Rd., 411045 Pune - Maharashtra <a href="http://www.turck.co.in">www.turck.co.in</a>
<b>Italy</b>	TURCK BANNER S.R.L. Via San Domenico 5, IT-20008 Bareggio (MI) <a href="http://www.turckbanner.it">www.turckbanner.it</a>
<b>Japan</b>	TURCK Japan Corporation ISM Akihabara 1F, 1-24-2, Taito, Taito-ku, 110-0016 Tokyo <a href="http://www.turck.jp">www.turck.jp</a>



<b>Korea</b>	Turck Korea Co, Ltd. B-509 Gwangmyeong Technopark, 60 Haan-ro, Gwangmyeong-si, 14322 Gyeonggi-Do <a href="http://www.turck.kr">www.turck.kr</a>
<b>Malaysia</b>	Turck Banner Malaysia Sdn Bhd Unit A-23A-08, Tower A, Pinnacle Petaling Jaya, Jalan Utara C, 46200 Petaling Jaya Selangor <a href="http://www.turckbanner.my">www.turckbanner.my</a>
<b>Mexico</b>	Turck Comercial, S. de RL de CV Blvd. Campestre No. 100, Parque Industrial SERVER, C.P. 25350 Arteaga, Coahuila <a href="http://www.turck.com.mx">www.turck.com.mx</a>
<b>Netherlands</b>	Turck B. V. Ruiterlaan 7, NL-8019 BN Zwolle <a href="http://www.turck.nl">www.turck.nl</a>
<b>Poland</b>	TURCK sp.z.o.o. Wroclawska 115, PL-45-836 Opole <a href="http://www.turck.pl">www.turck.pl</a>
<b>Romania</b>	Turck Automation Romania SRL Str. Siriului nr. 6-8, Sector 1, RO-014354 Bucuresti <a href="http://www.turck.ro">www.turck.ro</a>
<b>Russian Federation</b>	TURCK RUS OOO 2-nd Pryadilnaya Street, 1, 105037 Moscow <a href="http://www.turck.ru">www.turck.ru</a>
<b>Sweden</b>	Turck Sweden Office Fabriksstråket 9, 433 76 Jonsered <a href="http://www.turck.se">www.turck.se</a>
<b>Singapore</b>	TURCK BANNER Singapore Pte. Ltd. 25 International Business Park, #04-75/77 (West Wing) German Centre, 609916 Singapore <a href="http://www.turckbanner.sg">www.turckbanner.sg</a>
<b>South Africa</b>	Turck Banner (Pty) Ltd Boeing Road East, Bedfordview, ZA-2007 Johannesburg <a href="http://www.turckbanner.co.za">www.turckbanner.co.za</a>
<b>Turkey</b>	Turck Otomasyon Ticaret Limited Sirketi Inönü mah. Kayisdagi c., Yesil Konak Evleri No: 178, A Blok D:4, 34755 Kadiköy/ Istanbul <a href="http://www.turck.com.tr">www.turck.com.tr</a>
<b>USA</b>	Turck Inc. 3000 Campus Drive, USA-MN 55441 Minneapolis <a href="http://www.turck.us">www.turck.us</a>

# TURCK

Over 30 subsidiaries and  
60 representations worldwide!

100002085 | 2022/08



[www.turck.com](http://www.turck.com)